

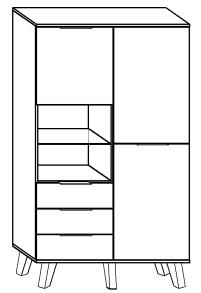

SVN-13 SZAFKA 2D3S

→ 100 ↑ 174 ↘ 40



x 9 a	x 18 b	x 18 c	x 28 d	x 6 e	x 6 f
x 12 g	x 10 (3x16) h	x 52 (3,5x16) i	x 22 (3,5x30) j	x 5 k	x 6 l
x 5 o	x 3 kpl. (350 mm) p		x 1 (300 mm) r		

x 110 m	x 1 n
90 min 90 min	

1 - FAZY MONTAŻU

A - OZNACZENIE ELEMENTÓW

a - OZNACZENIE AKCESORIÓW

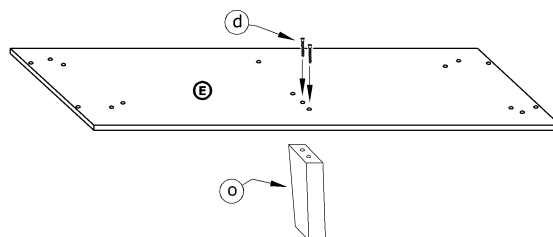
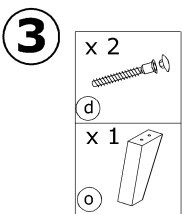
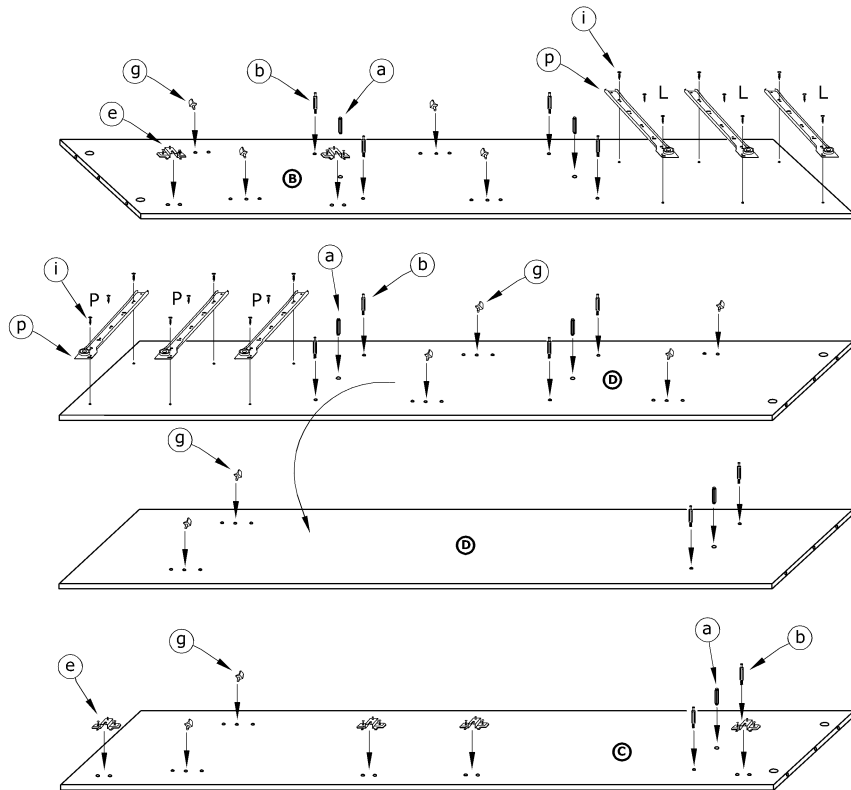
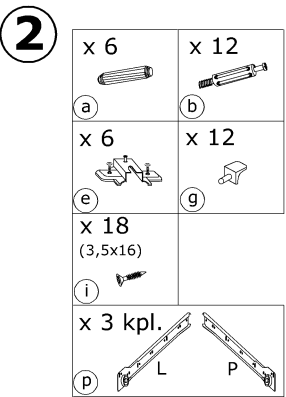
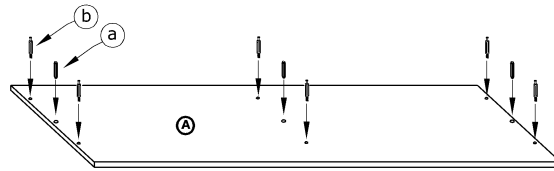
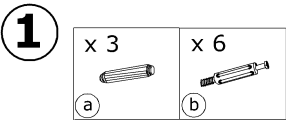

4

x 12



x 4

(3,5x16)



x 1

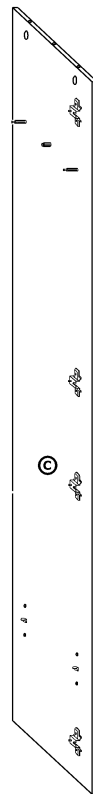
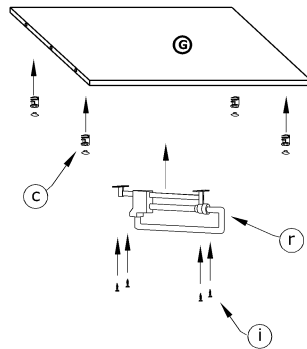
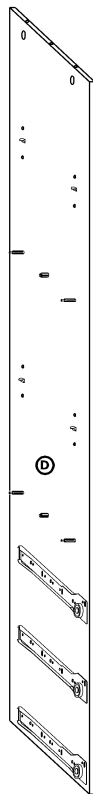
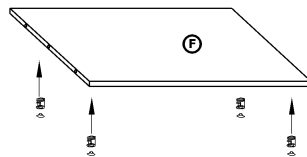
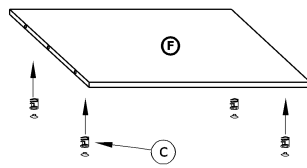
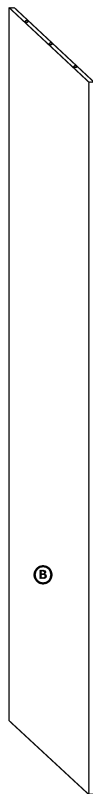

(r)

**5**

x 6





x 6



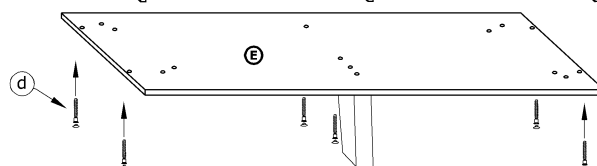
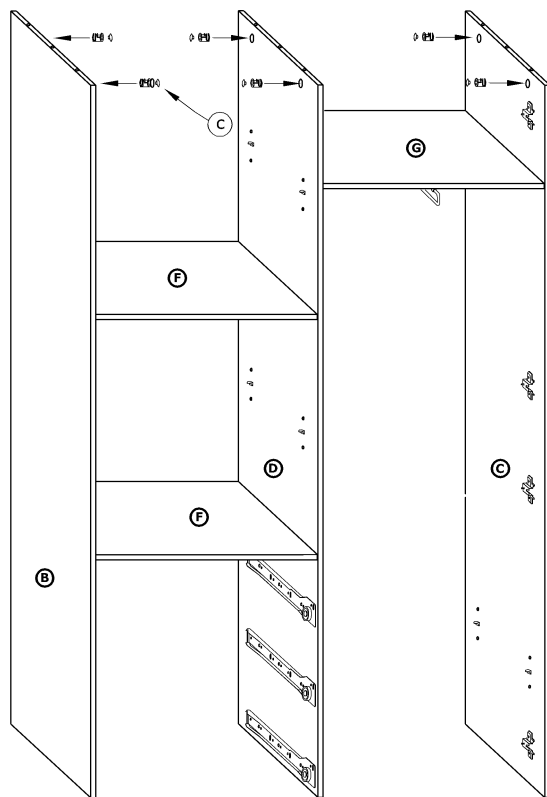
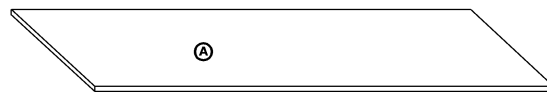





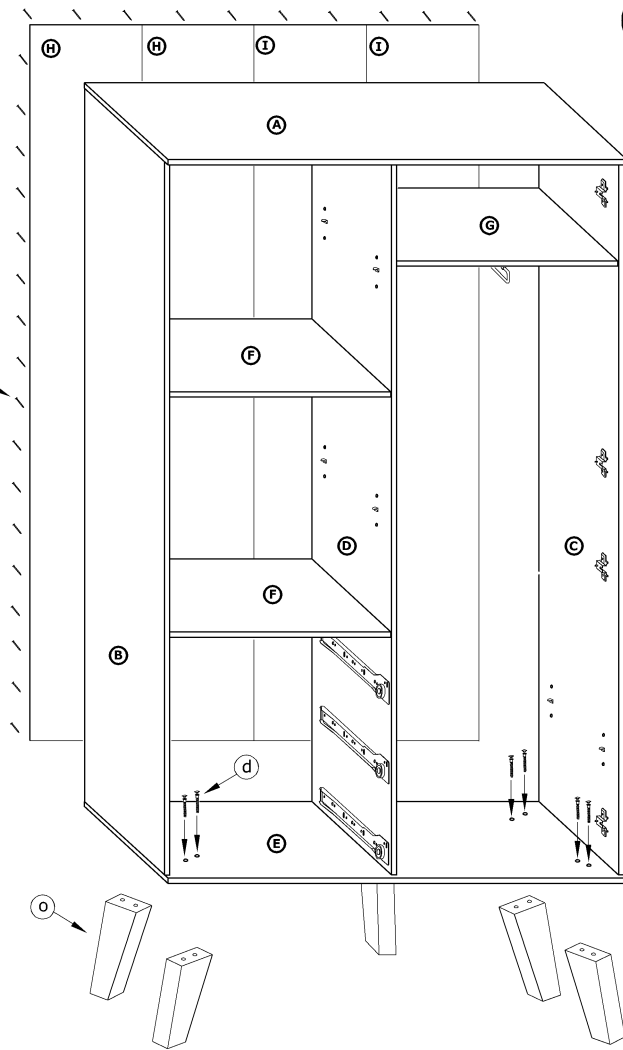

(d)







6

- x 8 
- x 65 
- x 4 

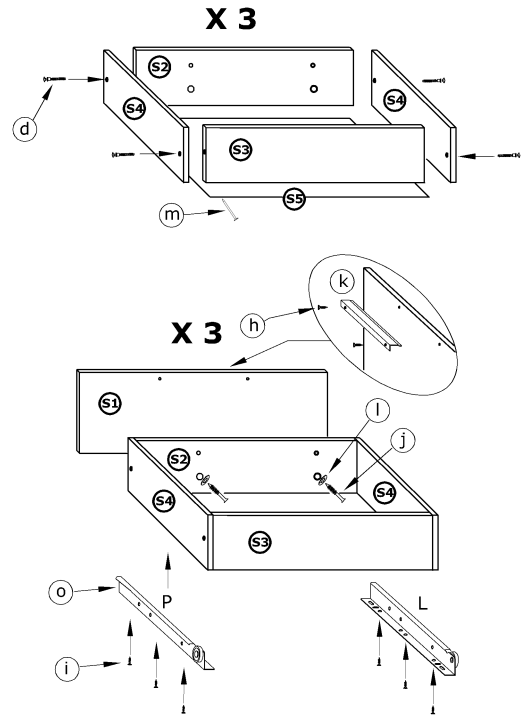
**7**

- | | | | |
|---|---|--|---|
| x 12  | x 6 (3x16)  | x 18 (3,5x16)  | x 6 (3,5x30)  |
| x 3  | x 6  | x 45  | |
| x 3 kpl.  | | | |

**8**

- x 6 
- x 4 (3x16) 
- x 12 (3,5x16) 
- x 16 (3,5x30) 
- x 2 