

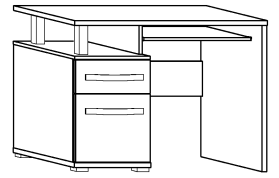

# ANG-02

## ANGEL- BIURKO 1D1S

-100 +77 \53



x 4  <b>(a)</b>	x 4  <b>(b)</b>	x 14  <b>(c)</b>	x 12  <b>(d)</b>	x 2  <b>(e)</b>	x 2  <b>(f)</b>
x 2  <b>(g)</b>	x 2  <b>(h)</b>	x 4  <b>(n)</b>	x 2  <b>(o)</b>	x 26 (3,5x16)  <b>(p)</b>	x 8 (4x20)  <b>(r)</b>
x 4 (4x25)  <b>(s)</b>	x 4 (3,5x30)  <b>(t)</b>	x 2  <b>(u)</b>	x 40  <b>(w)</b>	x 1  <b>(x)</b>	
x 2 kpl. (400 mm)  <b>(i)</b>	x 4  <b>(j)</b>	x 2 186 mm  <b>(k)</b>	x 2 160 mm  <b>(l)</b>	x 2  <b>(m)</b>	

**1** - FAZY MONTAŻU

**A** - OZNACZENIE ELEMENTÓW

**a** - OZNACZENIE AKCESORIÓW

**1**

x 4  
  
**(c)**

x 2  
186 mm  
  
**(k)**

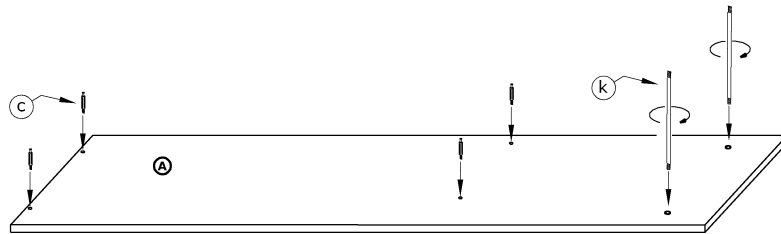

**2**

x 1 kpl.  
  
**(i)**

x 6  
(3,5x16)  
  
**(p)**

x 2  
  
**(o)**

x 2  
  
**(c)**

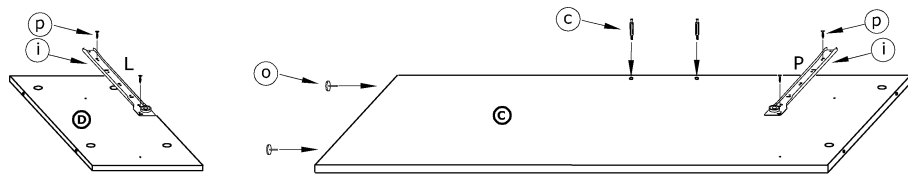

**3**

x 1 kpl.  
  
**(i)**

x 6  
(3,5x16)  
  
**(p)**

x 2  
  
**(f)**

x 4  
  
**(n)**

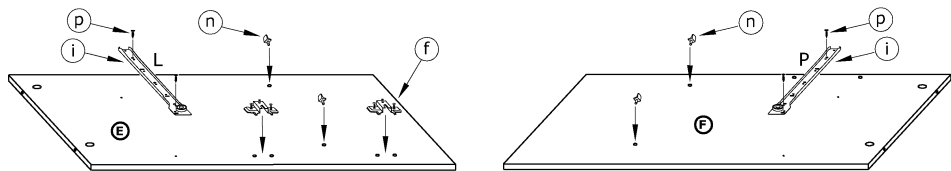

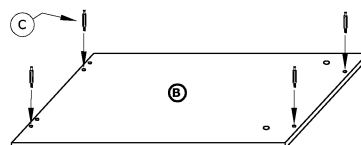

**4**

x 4  
  
**(c)**







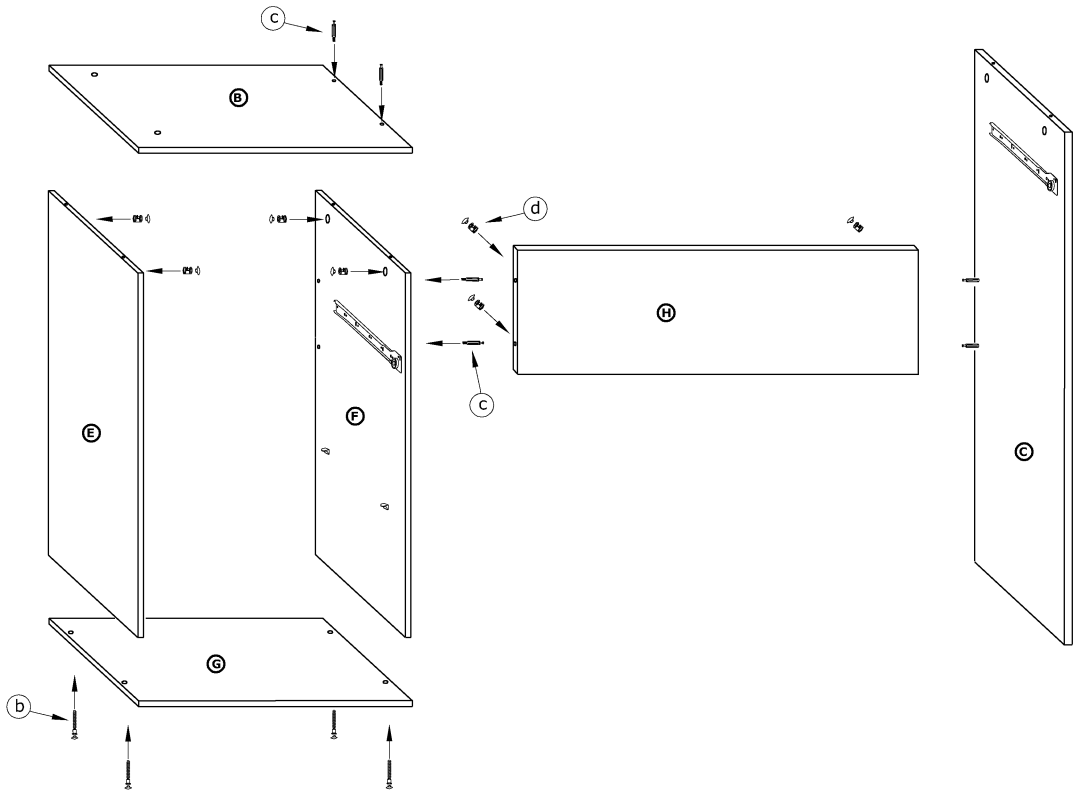

5

- x 4  

- x 4  

- x 8  



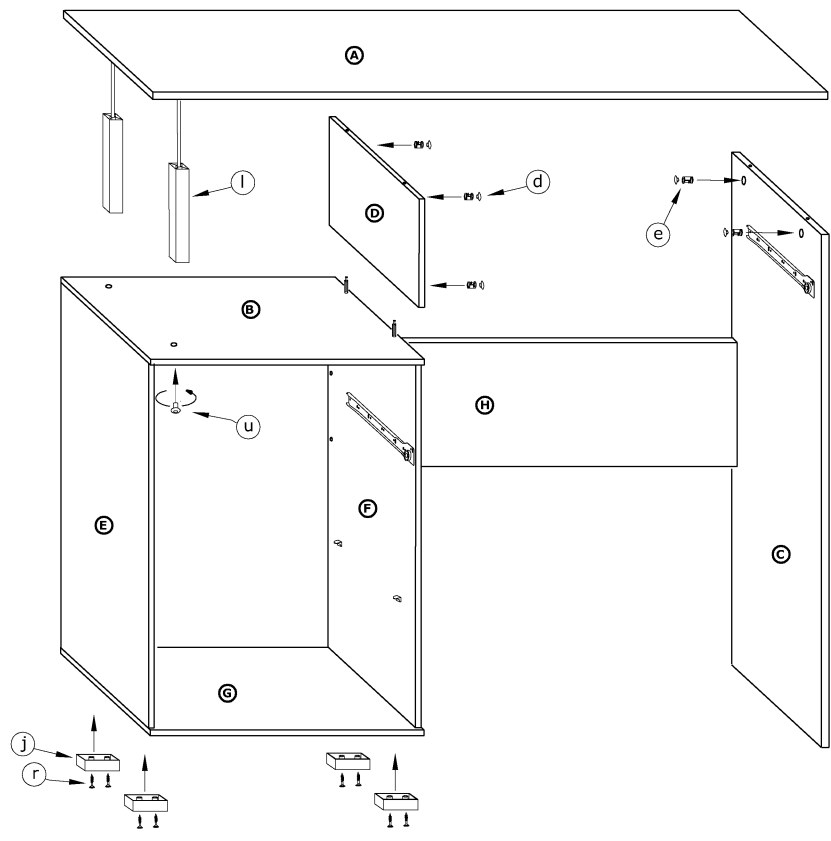







6

- x 4  

- x 2  

- x 2 160 mm  

- x 4  

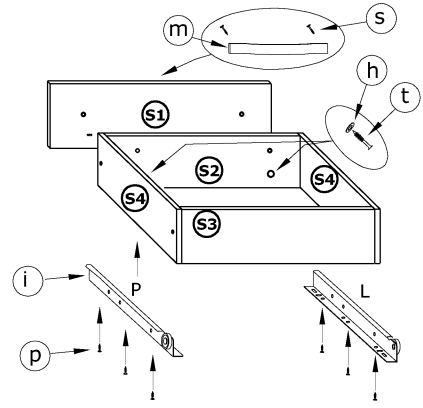
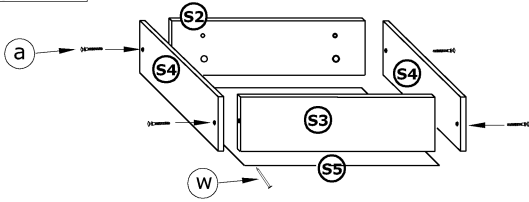
- x 8 (4x20)  

- x 2  





7

- x 4  (a)
- x 1  (i)
- x 1  (m)
- x 6 (3,5x16)  (p)
- x 2 (4x25)  (s)
- x 2 (3,5x30)  (t)
- x 2  (h)
- x 15  (w)







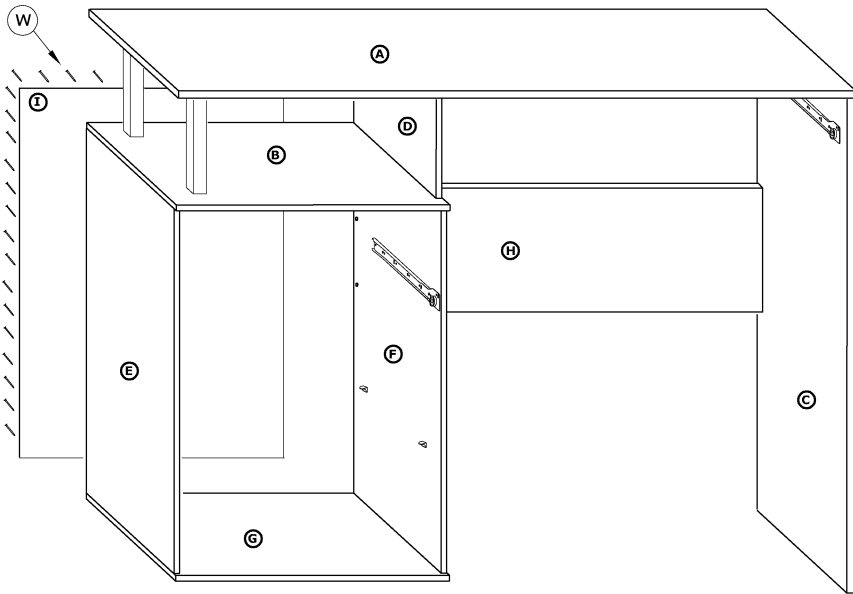

8

- x 25  (w)



9

- x 2  (g)
- x 1  (i)
- x 1  (m)
- x 10 (3,5x16)  (p)
- x 2 (4x25)  (s)
- x 2 (3,5x30)  (t)

