

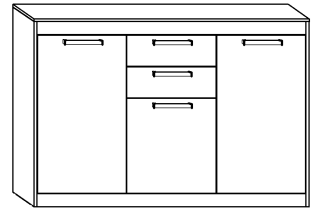

















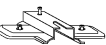

# MXS-09 KOMODA 3D2S

→ 148 × 102 × 44

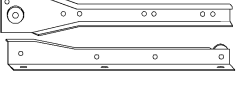

x 8  <b>(a)</b>	x 18  <b>(b)</b>	x 4  <b>(c)</b>	x 22  <b>(d)</b>	x 14  <b>(e)</b>	x 4  <b>(f)</b>
x 7  <b>(g)</b>	x 1  <b>(h)</b>	x 38 (3,5x16)  <b>(i)</b>	x 8 (3,5x30)  <b>(j)</b>	x 5  <b>(k)</b>	x 90  <b>(l)</b>
x 6  <b>(n)</b>	x 2  <b>(o)</b>	x 4  <b>(p)</b>	x 20  <b>(s)</b>	x 2 kpl. (350 mm)  <b>(r)</b>	x 1  <b>(m)</b>



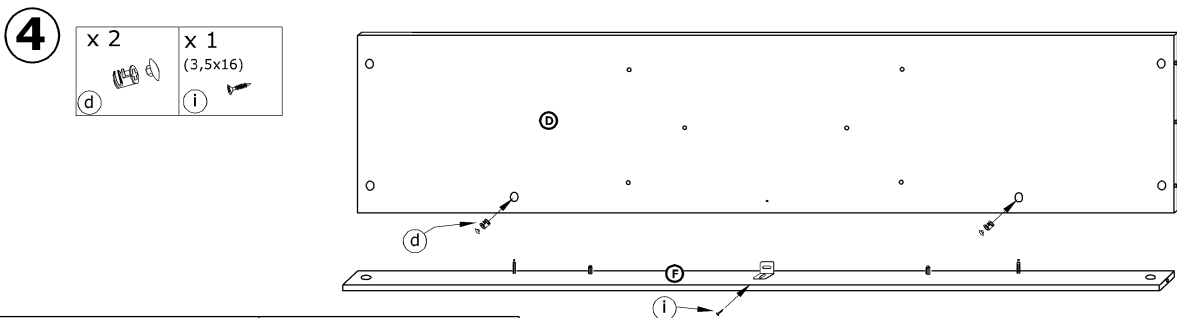
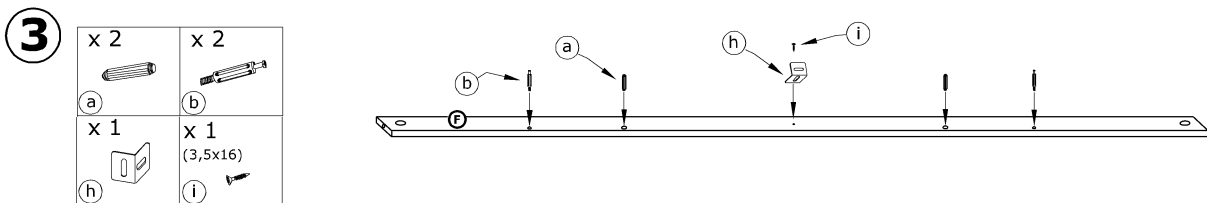
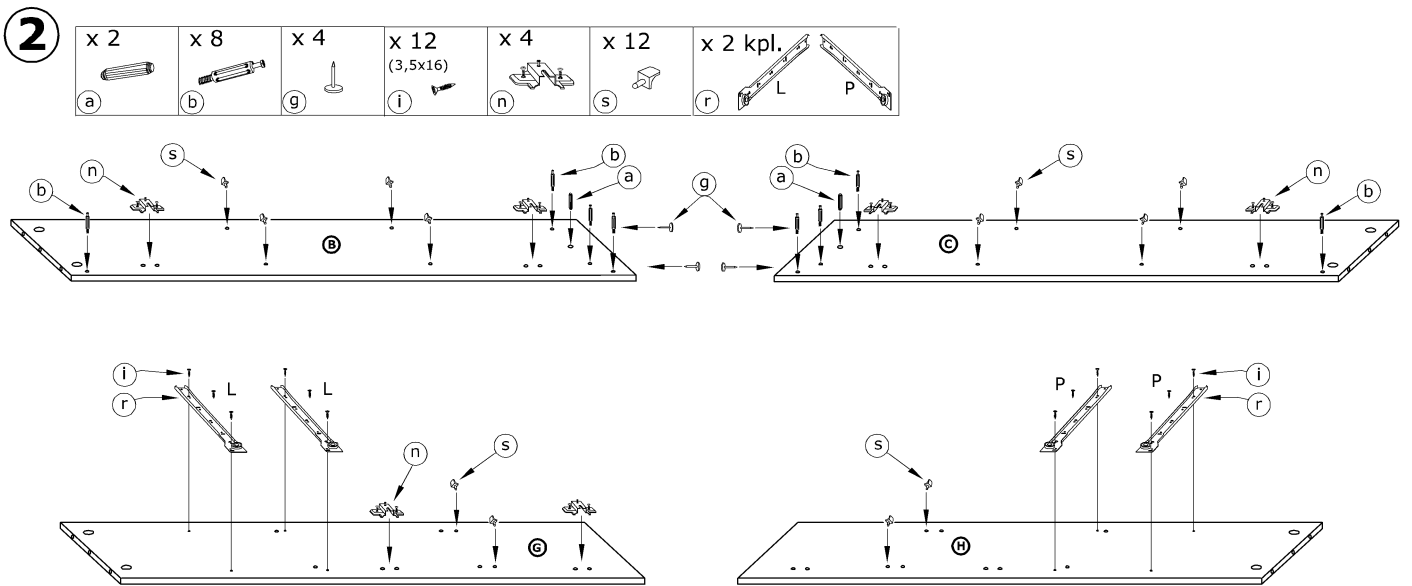
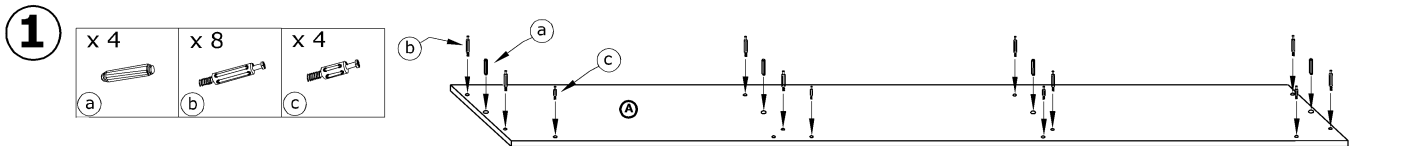

**1** - FAZY MONTAŻU

**A** - OZNACZENIE ELEMENTÓW

**a** - OZNACZENIE AKCESORIÓW



5

x 8	x 6	x 1	x 8
			

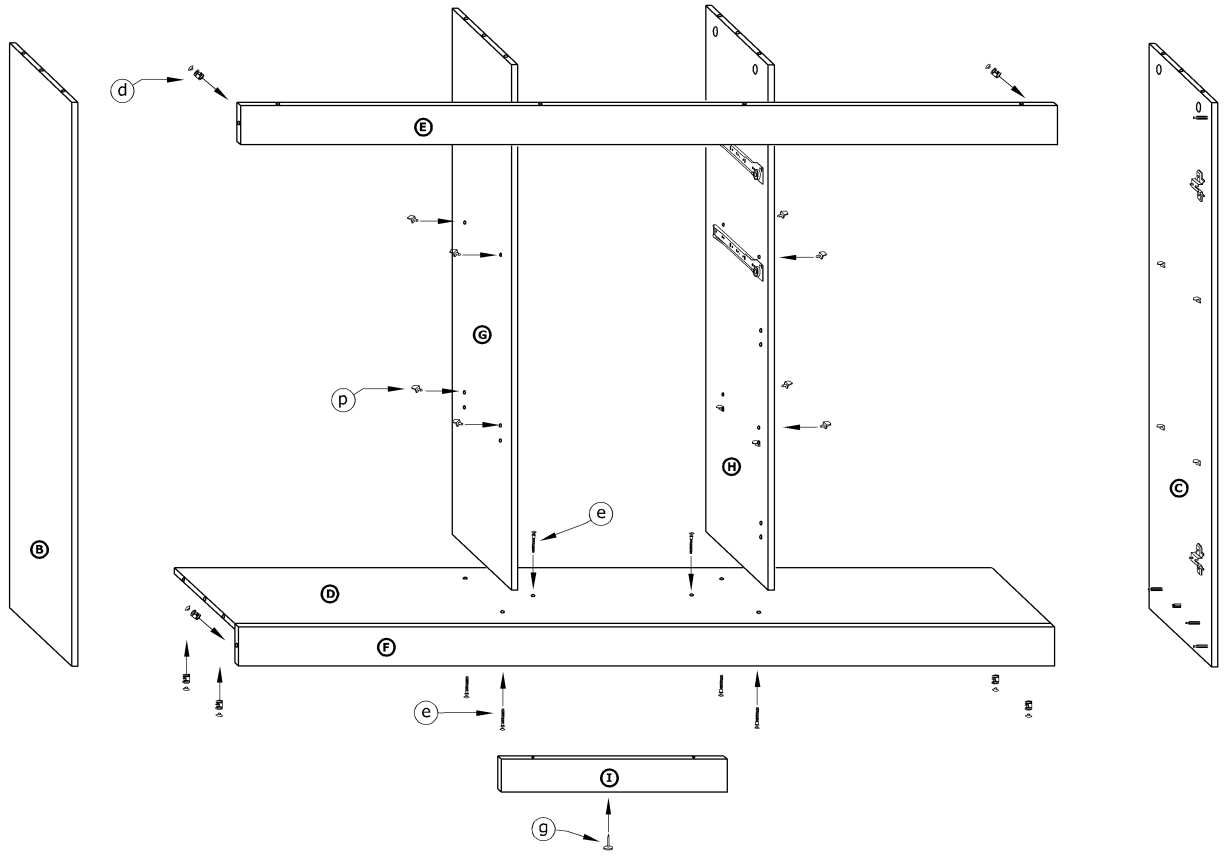

6

x 12	x 2
